

AUX

Multi-split air conditioners DC Inverter

Owner's manual

R32



Ceiling and floor indoor units

AUX-M-F09/I
AUX-M-F12/I
AUX-M-F18/I



Cassette indoor units

AUX-M-C09/I
AUX-M-C12/I
AUX-M-C18/I



Duct indoor units

AUX-M-D07/I
AUX-M-D09/I
AUX-M-D12/I
AUX-M-D18/I



Wall-mounted indoor units

AUX-07FH/I
AUX-09FH/I
AUX-12FH/I
AUX-18FH/I
AUX-24FH/I

Outdoor units AUX-C-12CAO, AUX-C-18CAO, AUX-C-24CAO, AUX-C-30CAO,
AUX-C-36CAO, AUX-C-42CAO, AUX-C-48CAO, AUX-C-60CAO

In result of continuous developing of the products, the manufacturer reserves the right to make modifications both of products and technical documentation for the devices.

CONTENTS





Warning	1
Safety Precautions	2
WEEE Warning	5
Operation	5
Notices	15
Care and Maintenance	16
Troubleshooting	17
Installation Guide	19
Selection of the installing position	22
Installation of the indoor unit	24
Installation of the outdoor unit	31
Pipe connection	32
Electrical connection	34
Test running	35
Maintenance Notice	36

warning

Warning: This air conditioner uses R32 flammable refrigerant.

Notes: Air conditioner with R32 refrigerant, if roughly treated, may cause serious harm to the human body or surrounding things.

- * The room space for the installation, use, repair, and storage of this air conditioner should be greater than 5m³.
- * Air conditioner refrigerant can not charge more than 1.7kg.
- * Do not use any methods to speed up defrost or to clean frosty parts except for particular recommended by manufacturer.
- * Not pierce or burn air conditioner, and check the refrigerant pipeline whether be damaged.
- * The air conditioner should be stored in a room without lasting fire source, for example, open flame, burning gas appliance, working electric heater and so on.
- * Notice that the refrigerant may be tasteless.
- * The storage of air conditioner should be able to prevent mechanical damage caused by accident.
- * Maintenance or repair of air conditioners using R32 refrigerant must be carried out after security check to minimize risk of incidents.
- * Please read the instruction carefully before installing, using and maintaining.

Symbol	Note	Explanation
	WARNING	This symbol shows that this appliance uses a flammable refrigerant. If the refrigerant is leaked and exposed to an external ignition source, there is a risk of fire.
	CAUTION	This symbol shows that the operation manual should be read carefully.
	CAUTION	This symbol shows that a service personnel should be handling this equipment with reference to the installation manual.
	CAUTION	This symbol shows that information is available such as the operating manual or installation manual.

Safety Precautions

Incorrect operation due to ignoring instruction will cause harm or damage. The seriousness is classified by the following indications:

WARNING

This symbol indicates the possibility of death or serious injury.

CAUTION

This symbol indicates the possibility of injury or damage to properties only.

WARNING

- 1. This appliance can be used by children aged from 8 years and above and persons with reduced physical, sensory or mental capabilities or lack of experience and knowledge if they have been given supervision or instruction concerning use of the appliance in a safe way and understand the hazards involved. Children shall not play with the appliance. Cleaning and user maintenance shall not be made by children without supervision.**
- 2. The air conditioner must be grounded. Incomplete grounding may result in electric shocks. Do not connect the earth wire to the gas pipeline, water pipeline, lightning rod, or telephone earth wire.**
- 3. Don't pull out the power plug during operating or with wet hands.**
It can cause electric shock or fire.
- 4. Don't pull the power cord when pull out the power plug.**
The damage of pulling power cord will cause serious electric shock.
- 5. The power plug must be inserted tightly.**
Otherwise, it can cause electric shock or overheating, even fire.
- 6. Children should be supervised to ensure that they do not play with the appliance.**



7. Don't share the socket with other electric appliance, and use the broken or unstandord cord. Otherwise, it can cause electric shock even fire.



8. Clean the dust on the plug regularly. Otherwise the dust mixed, humidity will result in insulation fault even fire.



9. An earth leakage breaker with rated capacity must be installed to avoid possible electric shocks.



10. Cut off the main power switch when not using the unit for a long time. Otherwise, it may cause product failure or fire.



11. Stop operation and cut off the main power in storm or hurricane. Operation with windows opened may cause electric shock.



12. Don't install air conditioner in a place where there is flammable gas or liquid. The distance between them should above 1m. It may cause fire.



13. Don't put a finger, a rod or other object into the air outlet or inlet. As a fan is rotating at a high speed, it will cause injury.



14. Don't touch the swinging wind vanes. It may clamp your finger and damage the driving parts of the wind vanes.



15. Don't attempt to repair the air conditioner by yourself. You may be hurt or cause further malfunctions.



16. Take care not let the remote controller and the indoor unit watered or being too wet, or may short circuit even caused fire.



17. Don't use liquid or corrosive cleaning agent wipe the air-conditioner and sprinkle water or other liquid either. Otherwise the inclosure will be damaged even electric shock.



18. This appliance is not intended for use by persons (including children) with reduced physical, sensory or mental capabilities, or lack of experience and knowledge, unless they have been given supervision or instruction concerning use of the appliance by a person responsible for their safety.

19. If the power supply cord is damaged, it must be replaced by the manufacture or its service agent or a similar qualified person.

20. Opening the electrical cover, there is a white line beside the terminal for servicing.



CAUTION

1. Don't install the indoor unit under sunshine directly.
2. Don't block air inlet or air outlet, otherwise, the cooling or heating capacity will be weakened, even cause system stop operating.
3. Don't apply the cold air to the body for a long time. It will deteriorate your physical conditions and cause health problems.
4. Close the windows and doors, otherwise, the cooling or heating capacity will be weakened.
5. If the air filter is very dirty, the cooling or heating capacity will be weakened. Please clean the air filter regularly .
6. It was prohibited to stand or put things onto the top of the outdoor, to avoid drop or damage. In no case should children be allowed to sit on the outdoor unit.
7. Set the suitable temperature, especially there are old people, children and patients in the room. Generally, keep the temperature difference for 5℃ between the inside and outside.
8. In case that the unit occurs closing down due to the severe interference from outer environments such as mobile phone, please cut off the plug and plug in to restart the air conditioner after several seconds .
9. It is forbidden to let the air conditioner keep precision instrumentation, artistic production for long time and make food fresh, otherwise abnormal using will cause damage and weaken.
10. It is forbidden to let children and the disabled use air-condition without other adult checking.
11. Open windows frequently after using air-condition for a long time.
12. If your air conditioner is not fitted with a supply cord and a plug, an all-pole switch must be installed in the fixed wiring and the distance between contacts should be no less than 3.0 mm.
13. If your air conditioner is permanently connected to the fixed wiring and have a leakage current that may exceed 10 mA. Leakage protector must be installed in the fixed wiring.
14. The power supply circuit should have leakage protector and air switch of which the capacity should be more than 1.5 times of the maximum current.

WEEE Warning

Meaning of crossed out wheeled dustbin:

Do not dispose of electrical appliances as unsorted municipal waste, use separate collection facilities.

Contact you local government for information regarding the collection systems available.

If electrical appliances are disposed of in landfills or dumps, hazardous substances can leak into the groundwater and get into the food chain, damaging your health and well-being.

When replacing old appliances with new ones, the retailer is legally obligated to take back your old appliance for disposals at least free of charge.



Operation

★ Remote Controller

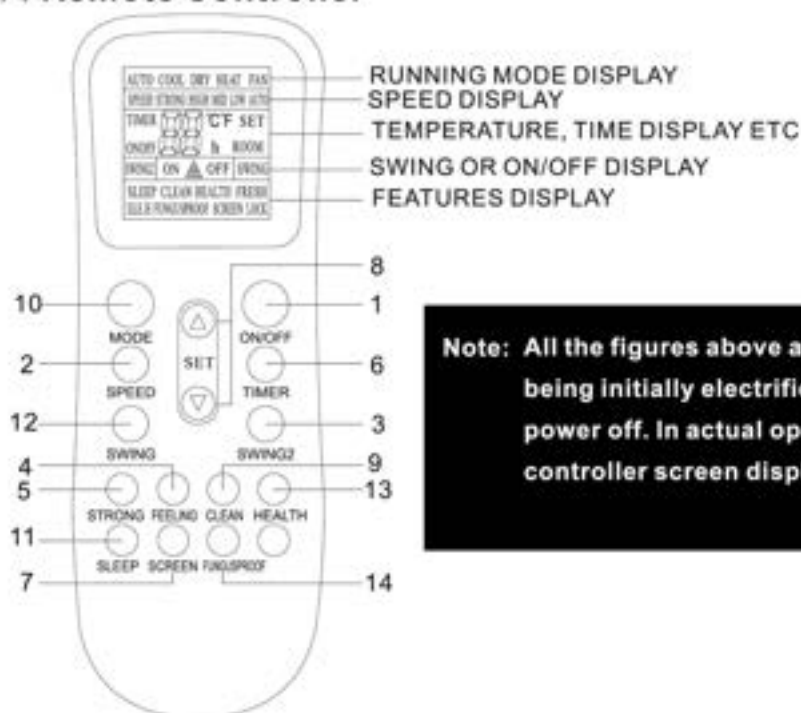

Note: All the figures above are the displays after being initially electrified or re-electrified after power off. In actual operations, the remote controller screen displays related items only.

Note: The picture is general remote controller, contains almost all of the function buttons.
They may be slightly different from material object(depend on model).

① **【ON/OFF】** button

You can start or stop the air-conditioner by pressing this button.

② **【SPEED】** button

You can select fan speed as the following:

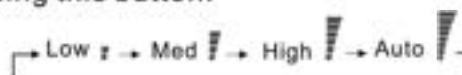

③ **【SWING2】** button

Press this button, the vertical wind direction vanes can rotate automatically, when you have the desired horizontal wind direction, press it again, the vertical wind direction vanes will be stopped at the situation of your choice.

④ **【FEELING】** button

When it displays “**FEELING**” button: Press this button can be used to set the feeling function. The LCD shows the actual room temperature when the function set and it shows the setting temperature when the function cancelled. This function is invalid when the appliance at the Fan mode.

⑤ **【STRONG】** button

Only under the state of cooling or heating mode, press this button, the fan speed is adjusted to strong auto-matically and the LCD displays “high fan”, the “strong” function is started to reach the highest cooling or heating.

⑥ **【TIMER】** button

Setting the “ON” timer time:

- When remote controller is at off state, press “TIMER” button, the LCD displays “TIMER On” and the timer time, the range of setting time is 0.5h to 24h.
- You can press the “ Δ ” or “ ∇ ” button to adjust the timer time, each touch will be set time to increase or reduce 0.5h before 10 hours ago, after ten hours will be set time to increase or reduce 1h per pressing, to enables your required timer.
- Press “TIMER” button again, to set the timer on function.
- You can set another function to insure the suitable state after air conditioner turn on(including mode, temperature, swing, fan speed and etc). The LCD will displays all your setting and keep it, when the timer reach to the set time, the air conditioner will be working according to your set automatically.

Setting the “OFF” timer time:

- When remote controller is at on state, press “TIMER” button, the LCD displays “TIMER OFF” and the timer time, the range of setting time is 0.5h to 24h.
- You can press the “ Δ ” or “ ∇ ” button to adjust the timer time, each touch will be set time to increase or reduce 0.5h before 10 hours ago, after ten hours will be set time to increase or reduce 1h per pressing, to enable your required timer.
- Press “TIMER” button again, to set the timer off function.

⑦ **【SCREEN】** button

You can let the LCD display working or not by pressing this button.

⑧ **【△】** or **【▽】** button

Press the “+” or “-” button, you can set the temperature range from 16℃ to 32℃, Display will change when you touch the button.

⑨ **【CLEAN】** button

This function is inactive of free match unit.

⑩ **【MODE】** button

Which enables you to select different operation mode, after each pressing, the operation mode will be changed. It shows in the following display.

AUTO→COOL→DRY→HEAT→FAN→AUTO

Remark: cold wind type has no heating function.

⑪ **【SLEEP】** button

1. Press the SLEEP button, the sleeping indicator light of indoor unit flashes on.
2. After the setting of sleeping mode, the cooling operation enables the set temperature to increase 1℃ after 1 hour and another 1℃ automatically after 1 hour.
3. After the setting of sleeping mode, the heating operation enables the set temperature to drop 2℃ after 1 hour and another 2℃ automatically after 1 hour.
4. The air-conditioner runs in sleeping mode for 7 hours and stops automatically.

Remark: press the MODE or ON/OFF button, the remote controller clears sleeping mode away.

⑫ **【SWING】** button

Press this button, the horizontal wind direction vanes can swing automatically, when you have the desired vertical wind direction, press it again, the horizontal wind direction vanes will be stopped at the situation of your choice.

⑬ **【HEALTH】** button

Press this button, you can turn on or off the health function.

⑭ **【FUNGUSPROOF】** button

This function is inactive of free match unit.

★Usage

Automatic operation mode

1. Press the ON/OFF button, the air-conditioner starts to operate.
2. Press the MODE button, select the automatic operation mode.
3. Press the SPEED button, you can select fan speed. You can select fan speed from LOW, MID, HIGH, AUTO.
4. Press the button again, the air-conditioner stops.

●**Cooling/Heating operation mode(cold wind type has no heating function)**

1. Press the ON/OFF button, the air-conditioner starts to operate.
2. Press the MODE button, select the Cooling or Heating operation mode.
3. Press the “△” or “▽” button, set the temperature, temperature can be set at 1℃ difference range from 16-32℃.

4. Press the SPEED button, you can select fan speed. You can select fan speed from LOW, MID, HIGH, AUTO.
5. Press the button again, the air-conditioner stops.

●Fan operation mode

1. Press the ON/OFF button, the air-conditioner starts to operate.
2. Press the MODE button, select the Cooling or Heating operation mode.
3. Press the SPEED button, you can select fan speed. You can select fan speed from LOW, MID, HIGH.
4. Press the button again, the air-conditioner stops.

Remark: In the circulation operation mode, to set the temperature is noneffective.

●Drying operation mode

1. Press the ON/OFF button, the air-conditioner starts to operate.
2. Press the MODE button, select the Dry operation mode.
3. Press the "△" or "▽" button, set the temperature, temperature can be set at 1°C difference range from 16-32°C.
4. Press the SPEED button, you can select fan speed. You can select fan speed from LOW, MID, HIGH, AUTO.
5. Press the button again, the air-conditioner stops.

Note:

This manual introduces function for all of the remote control, maybe you press one button without any reaction, well, the air-conditioner you bought hasn't this function.

★Fix batteries



1. Slide open the cover according the direction indicated by arrowhead.
2. Put into two brand new batteries (7#), position the batteries to right electric poles (+&-).
3. Put back the cover.

★Attention

1. Aim the remote controller towards the receiver on the air-conditioner.
2. The remote controller should be within 8 meters away from the receiver.
3. No obstacles between the remote controller and receiver.
4. Do not drop or throw the remote controller.
5. Do not put the remote controller under the forceful sun rays or heating facilities and other heating sources.
6. Use two 7# batteries, do not use the electric batteries.
7. Take the batteries out of remote controller before stop its using for long.
8. When the noise of transmitting signal can't be heard indoor unit or the transmission symbol on the display screen does not flare, batteries need be replaced.
9. If reset phenomenon occurs on pressing the button of the remote controller, the electric quantity is deficient and new batteries need to be substituted.
10. The waste battery should be disposed properly.

★ wire Control

Installation schematic

Method 1

1. Cut off the power of indoor unit.
2. As shown in Fig.1, use a flathead screw driver to pry the bottom groove of the wire controller lightly (too much force would damage circuit board), pry rotationally to open the back cover.



3. As shown in Fig.2, fix $\phi 4 * 20$ mm screws provided together with the back cover on 8 6 box, then pass lead wires through the back cover.

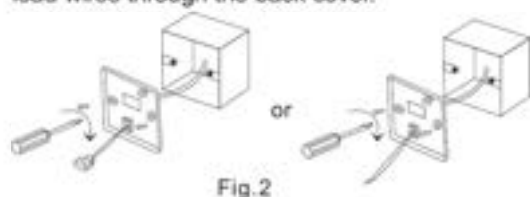

4. After connecting the connecting wire to the main body of the wire controller, as shown in Fig. 3, install main body part according to the following steps:
 - 1). Push the upper part of main body into the clip.
 - 2). Use the force of inclined top to install the lower part of main body (horizontal installation is prohibited, which is easy to damage the structural slot).



Method 2

1. Cut off the power of indoor unit.
2. Use a flathead screwdriver to pry the bottom groove of the wire controller, then open the upper cover.



3. Pass the wiring of the box inside the wall through the rear cover hole, according to the direction of the fig, fix the lower cover in the inner box of the wall.



4. Connect the power wiring of the box inside the wall to the connection terminal. (check to prevent short circuit)



5. The front cover is clamped on the back cover according to the direction of the fig, and the terminal is aligned with the junction hole to ensure that the junction is fitted with an interference-free reclosing cover.



Detailed operation instructions

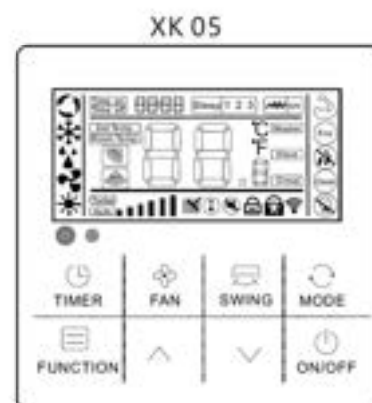

Note: The product adopts touch buttons. To ensure the validity of operation, please touch the center of each icon.

• **ON/OFF button**

Press- "ON / OFF" button to start or shutdown the unit.

• **▲ / ▼ button**—Temperature, time setting, function selection.

1. When the unit is running, press "▲" or "▼" button to increase or decrease the setting temperature by 1°C.

Under COOL, DRY, and HEAT modes, the setting temperature range is 16 °C ~ 32 °C;

The controller will display "Set temp." to show the setting temperature;

2. Under the function selection mode, press "▲" or "▼" button to select a function;

3. Under the timing mode, press "▲" or "▼" button to setting time.

• **Mode button**

When the unit is running, press "MODE" button, the running mode will switch according to the following order:

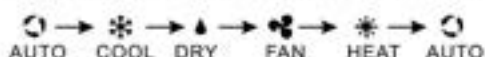

The initial setting temperature for each mode is 24 °C, and there is no temperature setting and automatic wind under FAN mode.

• **Fan button**--The setting of "Wind speed"

When the unit is running, press "Fan" button to switch fan speed in the following order:

3-gear of fan speed: Auto → → → → Auto
(Low) (Medium) (High)

4-gear of fan speed:

Auto → → → → → Auto
(Low) (Medium) (High) (Super-high)

In turbo mode, display fan speed (turbo + highest fan speed icon).

• **Swing button**--The setting of "Swing"

1. For the unit only has the function of up and down swing:

when the unit is running, press "Swing" button to enter or cancel up and down swing. At the time of opening up and down swing, " " is lighting. At the time of closed, swing icon will disappear. If the unit has positioning swing function, press "Swing" button to regulate the swing angle in the order:



2. For the unit only has the function of left and right swing:

when the unit is running, press "Swing" button to enter or cancel left and right swing. At the time of opening left and right swing, " " is lighting. At the time of closed, swing icon will disappear. If the unit has positioning swing function, press "Swing" button to regulate the swing angle in the order:

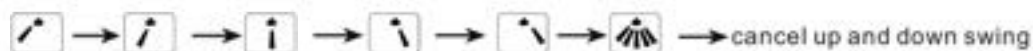

3. For the unit has the functions of left and right swing and up and down swing:

Press "Swing" button, the swing mode will switch in the following cycle order:

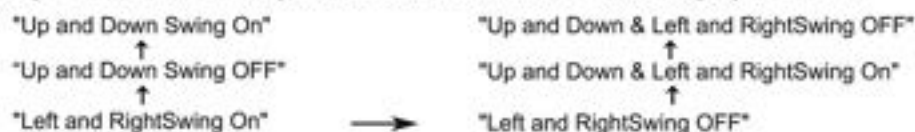

• Timer button

Users can set shutdown timing time when the unit is running, and set starting-up timing time when the unit is standby.

1. Press "Timer" button when the unit is running, the wired controller will display "Time off" and users can set the shutdown timing time; when the unit is standby, the wired controller will display "Time on", and users can set the starting-up timing time.

2. After entering timing time setting interface, the default timing time is 0.5H, at this moment, press "▲" or "▼" button to regulate the timing time. If the button is not pressed for 10 seconds, the timing setting will be canceled, and then return to the state of non-timing.

3. After the setting of timing, press "Timer" button again to confirm. The timing setting is successful and the time bar will stop blinking.

4. After the setting "Timer On" function, you can adjust the fan speed, running mode, set temperature, and swing angle. If there is no operation for 10 seconds, standby screen will be displayed.

5. Timing range: 0.5 ~ 24 hours.

press "▲" or "▼" button once, the timing time will increase or decrease by 0.5 hours.

When the timing time is more than 10 hours, press "▲" or "▼" button once, the timing time will increase or decrease by 1 hour.

6. Press "Timer" button or "ON / OFF" button to exit TimerON or TimerOFF.

• Comfort button--The setting of "Comfort" (XK04 Proprietary)

1. When the unit is running, press "Comfort" button to enter comfort function. The default setting temperature of COOL and DRY mode is 26℃, HEAT mode 24℃, setting temperature is adjustable. Fan speed is automatic and adjustable. The comfort function will be canceled if the running mode is changed.

2. Press "Comfort" button again to cancel comfort function.

Function description

The wire controller is for the general-purpose, specific functions for the controller are subject to the functions of your air conditioning unit.

Note: In the interface of function setting, press any button such as Timer, Fan, Swing, Mode, ON/OFF, and Comfort to exit the interface and conventional operation interface will display. If there is no operation for 10S, you can exit the interface.

Enter function: Press function button to enter function selection interface, press "▲" or "▼" to select a function, and the corresponding icon will flash, press "function" button again to confirm the function.

Cancel function: Press function button to enter function selection interface, press "▲" or "▼" to select a function and the corresponding icon will flash, press "function" button again to cancel the function.

• The setting of "Turbo" function

Turbo function: The fan speed will be ultra-high in turbo mode and users can achieve rapid cooling or heating effect.

Open turbo function:

1. When the unit is running in cooling or heating mode, press "Function" key to enter the interface of function selection.

2. Press "▲" or "▼" button to switch to turbo function, at this moment, "🌀" icon is flashing.

3. Press "Function" button to confirm turbo function, at this moment, icon "🌀", fan speed display is (Turbo) and highest fan speed icon).

Cancel turbo function:

1. When turbo function is opened, press "Function" button to enter the interface of function selection.

2. Press "▲" or "▼" switch to strong function, at this moment, icon "🌀" is flashing, press "Function" button to cancel strong function, and strong icon would not display.

Note: The unit without turbo function can also set turbo function on the wired controller, the performance is high fan speed, but "🌀" icon and "Turbo" icon do not display.

• The setting of "Sleep" function

Sleep function: Make indoor unit will run according to pre-set sleep temperature curve, which creates a comfortable sleep environment and improves sleep quality.

Enter sleep function:

1. In the state of running, press "Function" button to enter the interface of function selection.
2. Press "▲" or "▼" button to switch to sleep function, "Sleep" icon is flashing at this moment.
3. Press "Function" button to open sleep function, at this moment, icon "Sleep" is lighting.

Cancel "sleep" function:

1. When sleep function is opened, press "Function" button to enter the interface of function selection.
2. Press "▲" or "▼" button to switch to sleep function, "Sleep" icon is flashing.
3. Press "Function" button again to cancel sleep function.

• The setting of "ECO" function

Enter ECO function:

1. Press "Function" button to enter the interface of function selection.
2. Press "▲" or "▼" button to switch to ECO function, at this moment, "ECO" icon is flashing;
3. Press "Function" button again to confirm ECO function, at this moment, icon "ECO" is lighting.

Cancel ECO function:

1. Press "Function" button to enter the interface of function selection.
2. Press "▲" or "▼" button to switch to ECO function, at this moment, "ECO" icon is flashing;
3. Press "Function" button again to cancel ECO function.

• The setting of "Mildew-proof" function

Mildew-proof function: After shutdown, the air conditioner would automatically dry the moisture in the evaporator of indoor unit, so as to avoid mildewing.

Enter mildew-proof function:

1. Under COOL and DRY mode, press "Function" button to enter the interface of function selection.
2. Press "▲" or "▼" button to switch to the mildew-proof function setting interface, at this moment, icon "Mildew" is flashing;
3. Press "Function" button again to enter mildew-proof function, icon "Mildew" is lighting.

Cancel fungus-proof function:

1. When mildew proof function is on, press "Function" button to enter the interface of function selection.
2. Press "▲" or "▼" button to mildew proof function, icon "Mildew" is flashing;
3. Press "Function" button again to cancel mildew proof function, icon will "Mildew" disappear.

• The setting of "Light Sensation" function

Light sensation function: Detect the On and Off of indoor lamplight and switch to low fan speed when the lamplight is off, which can reduce the noise and create a comfortable sleep environment for users.

Enter light sensation function:

1. In the state of running, press "Function" button to enter the interface of function selection.
2. Press "▲" or "▼" to switch to light sensation function, icon "Light" is flashing;
3. Press "Function" button again to enter light sensation function, at this moment, icon "Light" is lighting.
4. When light sensation function is on, if the indoor lamplight is OFF and lasts for 20 minutes, the unit will automatically enter sleep mode. If the indoor lamplight is ON, and lasts for 20 minutes, the unit will cancel sleep mode and run according to the setting fan speed.

Cancel light sensation :

1. When light sensation function is on, press "Function" button to enter the interface of function selection.
2. Press "▲" or "▼" button to switch to light sensation function, icon "Light" is flashing.
3. Press "Function" button again to cancel light sensation function, icon "Light" will disappear.

The setting of "Clean" function

Clean function: The air conditioner can clean the evaporator automatically, which can not only keep air fresh, but also reduce the recession of cooling effect.

Enter clean function :

1. In the state of standby, press "Function" button to enter the interface of function selection, icon "☹" is flashing.
2. Press "Function" button again to confirm clean function, at this moment, icon "☺" is lighting.
3. When the unit is performing clean function, the wire controller will keep displaying icon "☹", until it is finished.

Display prompt function

• "WIFI" function display

If the unit is equipped with a WIFI function module, the icon "📶" is lighting on wire controller. If the unit is not equipped with a WIFI function module, the icon "📶" does not display.

• "Shielding" function display

When unit is locked by centralized control, the wired controller will display "🔒".

• "Mute" function display

When the unit enter silent function, display "🔇" icon, when silent function is cancelled, the icon does not display.

Note: The unit without silent function can also set silent through wired controller, but it shows in the way of low wind grade, but "🔇" does not display.

• "Oil Return / Defrost" function display

When the unit is running in the state of Oil Return or Defrost, "ⓘ" icon is lighting on wire controller. When the unit has finished Oil Return or Defrost process, "ⓘ" icon does not display.

• "Filter Screen Clean" function display

Filter screen cleaning reminder function: The unit can record its running time, when reaching the time set by the user, it will remind the user to clean the filter screen, so as to avoid prolonged cleaning and filter screen blockage, which can result in poor heating/cooling effect, abnormal protection, bacterial breeding, and other problems. When the running time reaches the filter screen cleaning reminder time set by a user, the unit will give out a reminder of filter screen cleaning, wired controller displays "🧼" icon, reminding the user to clean filter screen. At this moment, long press "Timer" button for 5S to cancel the reminder, then the icon does not display. A filter screen cleaning reset signal is sent to the unit.

• Celsius and Fahrenheit switching display

When users set Celsius to be valid, the wired controller will display Celsius temperature. When users set Fahrenheit to be valid, the wired controller will display corresponding Fahrenheit temperature synchronously.

• "Child Lock" function display

Press both "▲" and "▼" buttons for more than 5S to enter locking, the controller will display "🔒". In the state of locking, operations on the wired controller are disabled (but remote control receiving is valid). The method of unlocking: Press both "▲" and "▼" buttons for more than 5S or power off the unit to release the locking ("🔒" does not display).

• Remote control function

The wired controller can receive remote control commands and update the current status. Start-up the unit with remote controller, wired controller work in accordance with the state set on the remote controller and displays corresponding working mode;

• Room temperature sensorequipped on the wired controller

When the wire controller is equipped with a room temperature sensor and the sensor is not damaged, it is default that the ambient temperature detected by the sensor on the controller and the temperature value will be sent to the main PCB of the unit.

If the wire controller is not equipped with a room temperature sensor or the sensor is damaged, the room temperature will be detected by the temperature sensor of the unit itself.

• Fault display

When the unit has fault, the time bar will directly display the fault code and flash, the display mode is Er: MM (MM is the fault code, please read the corresponding product manual).

★ Attention

1. Aim the remote controller towards the receiver on the air-conditioner.
2. The remote controller should be within 8 meters away from the receiver.
3. No obstacles between the remote controller and receiver.
4. Do not drop or throw the remote controller.
5. Do not put the remote controller under the forceful sunrays or heating facilities and other heating sources.
6. Use two 7# batteries, do not use the electric batteries.
7. Take the batteries out of remote controller before stop its using for long.
8. When the noise of transmitting signal can't be heard indoor unit or the transmission symbol on the display screen doesn't flare, batteries need be replaced.
9. If reset phenomenon occurs on pressing the button of the remote controller, the electric quantity is deficient and new batteries need to be substituted.
10. The waste battery should be disposed properly.

★ Manual operation

☆ Manual operation

When the remote controller does not work or can not be found, please follow these steps:

1. As the unit is operating, you can press the "Auto button" to stop operating.
2. As the unit is stopping, you can press the "Auto button" to start operating.

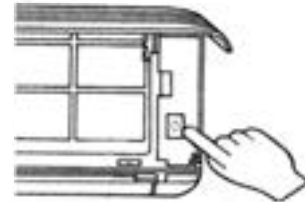

☆ Adjusting air flow direction

1. Adjusting horizontal air flow manually.

Use your hands to move the vertical airflow vane and change the horizontal wind direction.

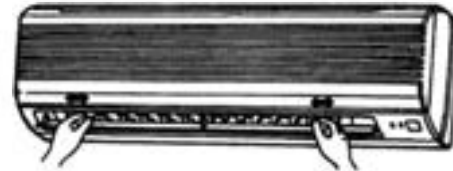

⚠ Note:

- a. Adjust the horizontal air flow direction before the air-conditioner starts. Don't insert your finger into air intake or outlet vents when the air-conditioner is operating.
- b. For appliance with auto pendulum wind function, please refer to "air conditioner remote controller instruction" for how to adjust horizontal air flow.

2. Adjusting vertical air flow direction(up-down)

Refer to "air conditioner remote controller instruction" for how to adjust vertical airflow direction through adjusting the horizontal airflow vane by remote controller.

⚠ Note:

- Adjust the vertical air flow direction by remote controller. When you adjust the horizontal airflow vane by hand, the machine may cause problem.
- Manual operation can be used temporarily in case you can not use remote controller or its batteries are exhausted.
- When the air-conditioner stops, the horizontal wind vane will close the wind outlet of air conditioner.

Notices

To prevent injury and property damage, Please pay attention to these following before operating the air conditioner.

★ Checking before operation

1. Make sure that the earth wire is connected safely and reliably.
2. Make sure the filter net is properly fixed.
3. Make sure that air outlet and inlet are not blocked.
4. Please clean the filter before starting the air-conditioner referring to page to 6 "Cleaning" for how to operate.
5. Check to see whether the outdoor install bracket is damage. If yes, please contact our Service center locally.

★ Safety tips

In order to use the air conditioner properly, please refer to its working temperature range. Otherwise, indoor unit automatic protection function may be activated, cooling or heating efficiency will be weakened.

The air-conditioner may can't run in normal followed under mentioned table

Cooling	Outdoor	>52°C
		<-10°C
	Indoor	<18°C

Heating	Outdoor	>24°C
		<-22°C
	Indoor	>30°C

★ Notices for R32 models

This product contains fluorinated greenhouse gases.

Refrigerant leakage contributes to climate change.

Refrigerant with lower global warming potential (GWP) would contribute less to global warming than a refrigerant with higher GWP, if leaked to the atmosphere. This appliance contains a refrigerant fluid with a GWP equal to [675]. This means that if 1 kg of this refrigerant fluid would be leaked to the atmosphere, the impact on global warming would be [675] times higher than 1 kg of CO₂, over a period of 100 years. Never try to interfere with the refrigerant circuit yourself or disassemble the product yourself and always ask a professional.

Care and Maintenance

★ Cleaning

☆ Cleaning the indoor unit

1. Turn off the air-conditioner and remove the electrical plug from the outlet.
2. Wipe the indoor unit with dry cloth or wet cloth which is dipped by cold water.

⚠ Note :

- Don't use water above 45°C to wash the panel, or it could cause deformation or depigment.
- Don't use thinner, polishing powder, benzene and other volatile chemicals.
- Don't use liquid or corrosive detergent clean the appliance and don't splash water or other liquid onto it, otherwise, it may damage the plastic components, even cause electric shock.

☆ Cleaning air filter

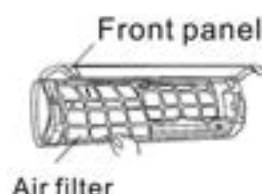
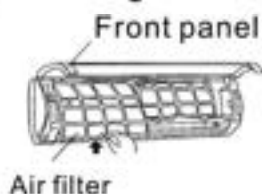

1. Raise up the front panel of indoor unit until it suddenly stop, then raise up the protruded part of air filter, and then take it out.
2. Use a vacuum cleaner or wash them with water, then dry it in the shade.
3. Reinsert the air filter into the indoor unit until being entirely fixed, then close the front panel.

★ Maintenance

1. Select "FAN" operation mode, make the air conditioner run a long time to dry.



3. Take out the batteries from the remote controller.



2. Turn off the air conditioner and cut off the power supply.



4. Clean air filters and other parts.



Troubleshooting

Check the following before requesting on service centre if the malfunction occurs.

Phenomenon	Troubleshooting																														
Air conditioner dose not operate at all	<ul style="list-style-type: none"> ● Has the power been shut down? ● Is the wiring loose? ● Is the voltage higher than 1.1 times of max rated voltage or lower than 0.9 times of min rated voltage? ● Is the fuse burnt? ● Does it reach the set time for start up? 																														
Remote controller is not available	<ul style="list-style-type: none"> ● Is the remote controller out of effective distance to the indoor unit? ● Is the battery exhausted? ● Are there any obstructions between the controller and the signal receptor? 																														
Cooling (Heating)efficiency is not good	<ul style="list-style-type: none"> ● Is the setting temperature suitable? ● Is the air inlet or outlet obstructed? ● Are air filter dirty? ● Is indoor fan speed set at low speed? ● Is there any heat source in your room? 																														
Indoor unit does not operate immediately when the air conditioner is restarted	Once the air conditioner is stopped, it will not operate in approximately 3 minutes to protect itself.																														
There is unusual smell blowing from the outlet after operation is started.	This is caused by the odour in the room permeated from building material, furniture, or smoke.																														
Sound of water flow can be heard during cooling operation	This is caused by the refrigerant flowing inside the unit.																														
Mist is emitted during cooling operation.	Because the air of the room is cooled down rapidly by the cold wind and it looks like the fog.																														
Mist is emitted during heating operation.	This generate due to moisture in defrosting process.																														
A low hissing sound is caused by the refrigerant flowing.	<ul style="list-style-type: none"> ● Low noise can be heard during operation ● A low squeak sound is caused by the deformation of plastic due to temperature. 																														
<p>Mode interfere</p> <p>For the reason that all indoor units ues one outdoor unit, outdoor unit can only run with same mode(cooling or heating), so, when the mode you set is different from the mode, that outdoor is running with, mode interfere occurs. Following shows the mode interfere scene.</p>	<table border="0"> <thead> <tr> <th></th> <th>cooling</th> <th>dry</th> <th>heating</th> <th>fan</th> <th></th> </tr> </thead> <tbody> <tr> <td>cooling</td> <td>✓</td> <td>✓</td> <td>×</td> <td>✓</td> <td>✓ --normal</td> </tr> <tr> <td>dry</td> <td>✓</td> <td>✓</td> <td>×</td> <td>✓</td> <td>×</td> </tr> <tr> <td>heating</td> <td>×</td> <td>×</td> <td>✓</td> <td>✓</td> <td>×</td> </tr> <tr> <td>fan</td> <td>✓</td> <td>✓</td> <td>✓</td> <td>✓</td> <td>×</td> </tr> </tbody> </table> <p>outdoor unit always run with the mode of first indoor unit that turned on. When the setting mode of following indoor unit is interfere with it, 3 beeps would be heard, and the indoor unit interfered with the normal running units would turn off automatically.</p>		cooling	dry	heating	fan		cooling	✓	✓	×	✓	✓ --normal	dry	✓	✓	×	✓	×	heating	×	×	✓	✓	×	fan	✓	✓	✓	✓	×
	cooling	dry	heating	fan																											
cooling	✓	✓	×	✓	✓ --normal																										
dry	✓	✓	×	✓	×																										
heating	×	×	✓	✓	×																										
fan	✓	✓	✓	✓	×																										

Fault code

When the air conditioner fails, the LED light or digital tube on indoor display board will show the corresponding fault code according to different fault.

Specific correspondis as follows:

S/N	Fault description	Fault code display	Unit phenomenon
1	Over/low power voltage protection	F7	Stop
2	Over/low main line voltage protection	F1	Stop
3	Over power current protection	P8	Stop
4	Low pressure switch protection	H6	Stop
5	High pressure switch protection	P2	Stop
6	Indoor high temp protection in heating mode	P6	Stop
7	Drain pump failure	H1	Stop
8	Communication failure of wire controller	H2	Stop
9	IPM module protection	L9	Stop
10	Indoor fan motor failure	E4	Stop
11	Outdoor ambient temp sensor failure	F6	Stop
12	Overload protection in cooling mode	P4	Stop
13	Suction temp sensor failure	FA	Stop
14	High discharge temp protection	P5	Stop
15	Low discharge temp protection	H5	Stop
16	4way-valve failure	H8	Stop
17	Indoor coil temp sensor failure	E3	Stop
18	Indoor ambient temp sensor failure	E1	Stop
19	Outdoor coil temp sensor failure	E2	Stop
20	Communication between IDU and ODU is fault	E5	Stop
21	Evap inlet temp sensor failure	H3	Stop
22	Evap outlet temp sensor failure	H4	Stop
23	Outdoor DC fan motor failure	F1	Stop
24	Outdoor DC fan motor current abnormal protection	LD	Stop
25	DC fan motor phase lost protection	LE	Stop
26	DC fan motor step lost protection	LF	Stop
27	DC fan motor IPM protection	LH	Stop

Note: For the unit with digital tube, it will show the corresponding fault codes; for the unit no digital tube only LED light, it will only show the corresponding fault codes with timer light.

Installation Guide

★ Guide for customer

1. Please read the instructions carefully before installation of the air-conditioner.
2. The installation should be carried out by specialists.
3. Installation the air-conditioner and connecting the pipe and wires must be strict to reference the instructions.
4. The wiring must be done by qualified electrician according to the electrical safety requirements.
5. The customer should have a qualified power supply which coincides with the tag of air conditioner, the normal voltage should be in the range of 90-110% of its rated voltage.
6. The air conditioner must be well grounded, the switch of the main power of air-conditioner must be reliably grounded.

★ Notices

1. The air conditioner must be installed on well strong supporter.
2. The appliance shall be installed in accordance with national wiring regulations.
3. Fix the machine firmly, otherwise it will produce abnormal noise and vibration.
4. Install the outdoor unit in the place where it wouldn't disturb your neighbour.
5. The method of connection of the appliance to the electrical supply and inter connection of separate somponents, please see the electric connection elements shart which stick on the machine.
6. If the power supply cord is damaged, it must be replaced by the manufacture or its service agent or a similar qualified person.
7. After installation, the power plug should be easily reached.

Notices of installation

★ Unpacking Inspection

- Open the box and check air conditioner in area with good ventilation (open the door and window) and without ignition source.
Note: Operators are required to wear anti-static devices.
- It is necessary to check by professional whether there is refrigerant leakage before opening the box of outdoor machine; stop installing the air conditioner if leakage is found.
- The fire prevention equipment and anti-static precautions shall be prepared well before checking. Then check the refrigerant pipeline to see if there is any collision traces, and whether the outlook is good.

★ Safety Principles for Installing Air Conditioner

- Fire prevention device shall be prepared before installation.
- Keep installing site ventilated.(open the door and window)
- Ignition source,smoking and calling is not allowed to exist in area where R32 refrigerant located.
- Anti-static precautions in necessary for installing air conditioner, e.g. wear pure cotton clothes and gloves.
- Keep leak detector in working state during the installation.
- If R32 refrigerant leakage occurs during the installation, you shall immediately detect the concentration in indoor environment until it reaches a safe level. If refrigerant leakage affects the performance of the air conditioner, please immediately stop the operation, and the air conditioner must be vacuumed firstly and be returned to the maintenance station for processing.
- Keep electric appliance, power switch, plug, socket, high temperature heat source and high static away from the area underneath sidelines of the indoor unit.
- The air conditioner shall be installed in an accessible location to installation and maintenance, without obstacles that may block air inlets or outlets of indoor/outdoor units, and shall keep away from heat source, inflammable or explosive conditions.
- When installing or repairing the air conditioner and the connecting line is not long enough, the entire connecting line shall be replaced with the connecting line of the original specification; extension is not allowed.
- Use new connection pipe, unless re-flaring the pipe.

Notices of installation

★ Requirements For Installation Position

- Avoid places of inflammable or explosive gas leakage or where there are strongly aggressive gases.
- Avoid places subject to strong artificial electric/magnetic fields.
- Avoid places subject to noise and resonance.
- Avoid severe natural conditions (e.g. heavy lampblack, strong sandy wind, direct sunshine or high temperature heat sources).
- Avoid places within the reach of children.
- Shorten the connection between the indoor and outdoor units.
- Select where it is easy to perform service and repair and where the ventilation good.
- The outdoor unit shall not be installed in any way that could occupy an aisle, stairway, exit, fire escape, catwalk or any other public area.
- The outdoor unit shall be installed as far as possible from the doors and windows of the neighbors as well as the green plants.

★ Installation environment inspection

- Check nameplate of outdoor unit to make sure whether the refrigerant is R32.
- Check the floor space of the room. The space shall not be less than usable space(5m^2) in the specification. The outdoor unit shall be installed at a well-ventilated place.
- Check the surrounding environment of installation site: R32 shall not be installed in the enclosed reserved space of a building.
- When using electric drill to make holes in the wall, check first whether there is pre-buried pipeline for water, electricity and gas. It is suggested to use the reserved hole in the roof of the wall.

Selection of the installing position

★ Indoor Unit

- There is no heating and steaming source nearby.
- No obstacles for installing position nearby.
- Keep good air circulation.
- Convenient to adopt measures to reduce noises.
- Do not install them near the doorway.
- Make sure to have the distance between the ceiling, wall, furniture and other obstacles.
- 2 meters high above the floor.

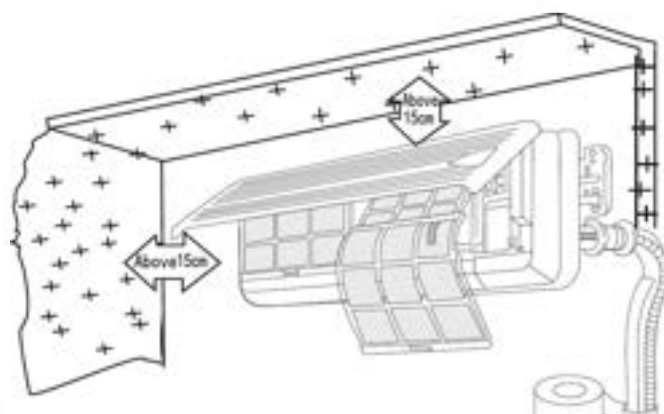

★ Outdoor Unit

- In case that you put up a canopy to protect it from rains and sunrays, pay attention not to cause any obstacles for the heating dispersion for the condenser.
- Do not grow animals or plants near the installation location for the cold and hot air out will affect them.
- Make sure to have the distance specified in the picture between ceiling, wall, furniture and other obstacles.
- Stay away from heating source and inflammable air.
- The installation base and supporting frame should be strong and secure. The machine should be at plane surface.

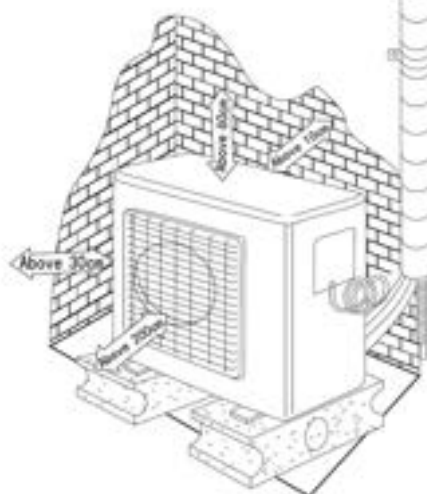

You can adjust the vertical location of indoor and outdoor units according to the installation requirement. If the outdoor unit is installed higher than indoor units and $H_1, H_2, H_3, H_4, H_5 > 7\text{m}$, please set the oil bend every 3 meters on the vertical gas pipe. In other cases don't need to install oil bend.

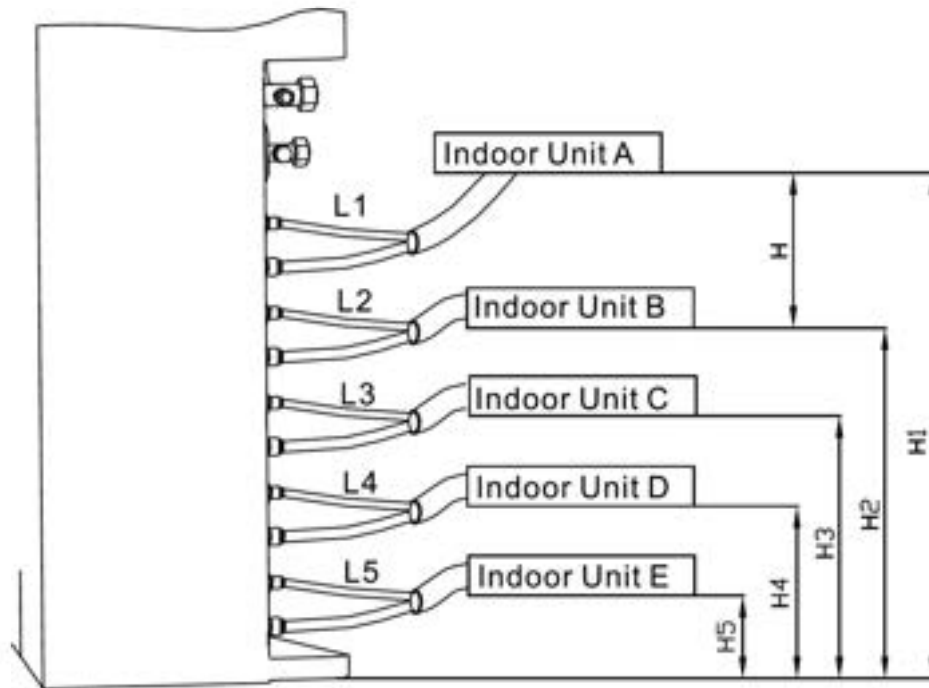

Note : All the requirements below should be met at the same time:
 $L_1+L_2 \leq 40\text{m}$ $L_1+L_2+L_3 \leq 60\text{m}$ $L_1+L_2+L_3+L_4 \leq 80\text{m}$ $L_1+L_2+L_3+L_4+L_5 \leq 80\text{m}$
 $H \leq 10\text{m}$ $H_1, H_2, H_3, H_4, H_5 \leq 15\text{m}$

Each machine's standard piping is 7.5 meters, if the total liquid pipe length of indoor units more than $7.5 \cdot N$ meters, additional refrigerant is need. $N=1,2,3,4,5$

PIPE LENGTH AND HEIGHT DIFFERENCE

Pipe length	Up to $7.5 \cdot N$ m	No additional charge is required
	Exceeding $7.5 \cdot N$ m	Additional charge is required.
Refrigerant to be added	$20\text{g/m} \times (\text{refrigerant piping length(m)} - 7.5 \cdot N)$	

Installation of the indoor unit

★ Ceiling & Floor Air Conditioner Unit

■ Select installation site

※Ensure the following conditions are satisfied and confirm the position with the customer.

1. There are no obstacles to hinder air circulation. The air should be able to reach every part of the room.
2. The installation site should be convenient for water draining.

⚠ Warning

3. Ensure the installation position is able to take four times of the unit weight. There should be no increase in noise and vibration.

4. The indoor unit must be away from source of heat or steam. It should be some distance from the entrance to the room.
5. It should be close to the dedicated power supply designated for its use.
6. It should be as close as possible to the outdoor unit
7. It should not be exposed to direct sunlight and away from sources of moisture
8. The height of the unit above the ceiling should allow for correct drainage from the unit
9. Do not install the unit in a washing or drying room risk of electric shock.
10. In the inlet and outlet of indoor unit, protective barriers should be installed to prevent finger from inserting or contacting the fan with high speed and metal fin.

■Matters requiring attention 1

In the following places, please carry out a full inspection and take appropriate action.

1. In restaurants, kitchens and other eating places, dust, flour, grease steam and other cooking by products will easily attach to the indoor fan, heat exchanger and drain pump. This will cause the performance to reduce and cause the unit to spray water, leak and may lead to the drain pump or other components to fail.

Please consider adopting the following improvement measures.

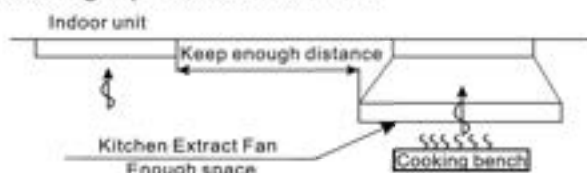

The capacity of the kitchen extract fan and extract hood should be great enough to ensure that the oil, steam, flour and other cooking products will be exhausted through it and not attracted into the air conditioner.

The indoor unit should be far enough away from the cooking and food preparation equipment to ensure that cooking products are not attracted into the unit.

2. When installing the unit in a factory, ensure it is situated in a place where it will not be contaminated by oil, powder, iron filings or dust.
3. Do not install near potential sources of combustible gas
4. Do not install where acidic or corrosive gases are present

■Matters requiring attention 2

Do not drop the indoor unit or allow it to fall during transport.

■ Select installation site

-Ceiling & Floor Air Conditioner Unit

1. Ceiling Installation

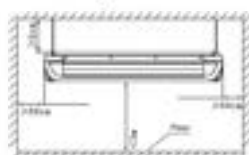

2. Wall-Mounted Installation



■ The dimension of indoor unit

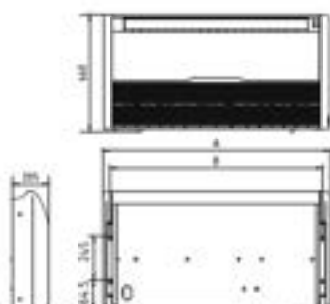

Unit: mm

Type	A	B
9000BTU 12000BTU 18000BTU	929	840

★ Installation

There are two ways of indoor unit installation: ceiling and Wall-Mounted Installation.

■ Ceiling installation

1. Select the suspension foundation

The suspension foundation is a structure of either wooden frame or reinforced concrete. It must be firm and reliable to bear the weight of more than 200kg and capable of bearing vibration for long periods.

2. Fixing of suspension foundation

Fix the suspension foundation bolts either as shown on the right or by a steel or wooden bracket.

3. The suspension of indoor unit

the indoor unit should be suspension as shown below:

- ① Adjust the relative positions of the suspension hooks .
- ② Tighten the nuts and ensure that the hooks are tightly connected to the nuts and shims.
- ③ After the unit is installed ensure it is secure and does not shake or sway.

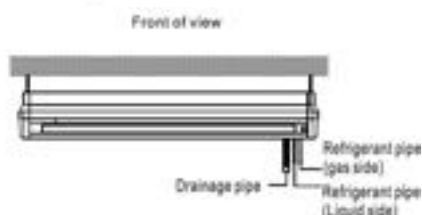
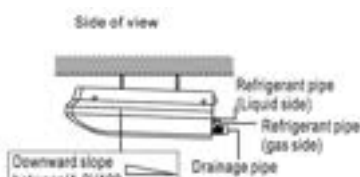
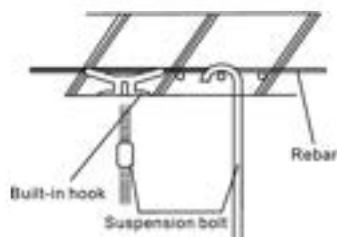

! Caution

1. In order to ensure the drainage water come out successfully, the unit must be declined to the bottom side of unit when finished installation.

2. Please make sure the front side higher, otherwise it may cause drainage come out from the air outlet.

4. Installation of drainage pipe

- ① The drain pipe should be properly insulated to prevent the generation of condensation.
- ② Pipes it should be installed with a downward gradient(1/100~150) to allow the water to drain away.
- ③ The pipe should not rise at any point.

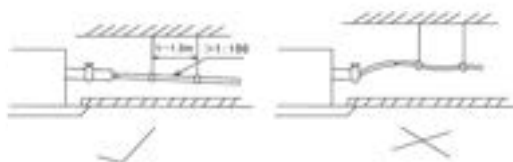

■ Wall-Mounted Installation



! Caution

The unit must be horizontal or declined to drain hose when finished installation.

★ Built In Ceiling Cassette Split Air Conditioner Unit

■ Select installation site

To ensure ease of maintenance please allow the space shown below for access to the unit

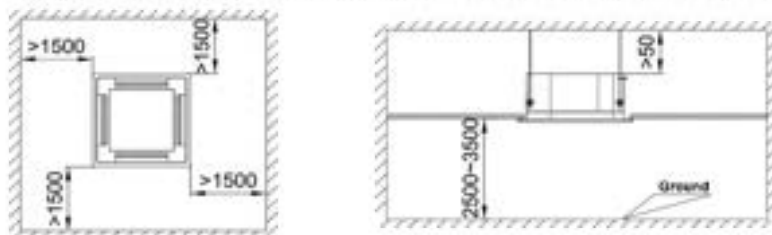

※ Ensure the following conditions are satisfied and confirm the position with the customer.

1. There are no obstacles to hinder air circulation. The air should be able to reach every part of the room.
2. The distance away from the ceiling and obstacles is shown in the below drawing.

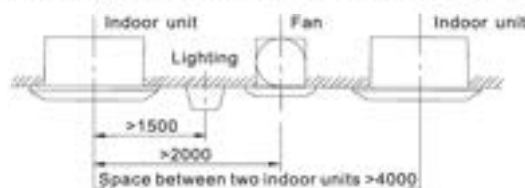

3. The installation site should be convenient for water draining (See "Installation of drainage pipe" for details.)

⚠ Warning

4. Ensure the installation position is able to take four times of the unit weight. There should be no increase in noise and vibration.

5. The indoor unit must be away from source of heat or steam. It should be some distance from the entrance to the room.
6. It should be close to the dedicated power supply designated for its use.
7. It should be as close as possible to the outdoor unit
8. It should not be exposed to direct sunlight and away from sources of moisture
9. The height of the unit above the ceiling should allow for correct drainage from the unit
10. Do not install the unit in a washing or drying room risk of electric shock.

■ The dimension of indoor unit



9000BTU
12000BTU
18000BTU

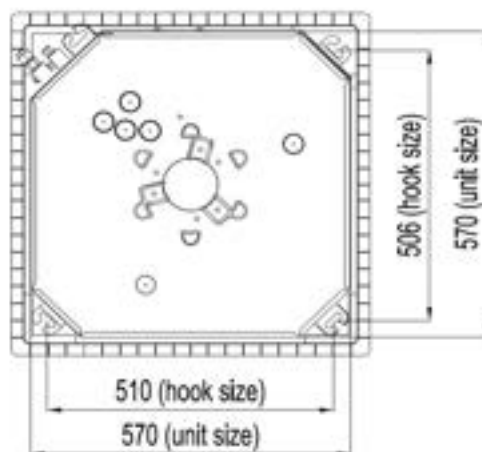

■ Suspension foundation of the indoor unit

1. Select the suspension foundation

The suspension foundation is a structure of either wooden frame or reinforced concrete. It must be firm and reliable to bear the weight of more than 200kg and capable of bearing vibration for long periods.

2. Fixing of suspension foundation

Fix the suspension bolts either as shown on the right or by a steel or wooden bracket.

If this unit is installed on a sloping ceiling, a cushion block should be installed between the ceiling and the air outlet panel, in order to ensure that the unit is installed on a level surface.

This is as shown in the drawing on the right

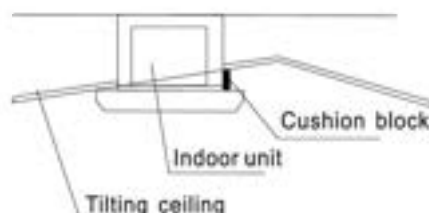
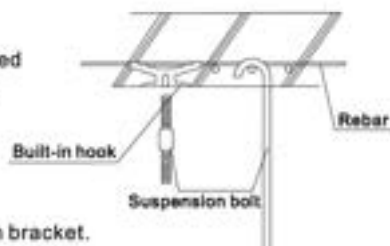

■ The suspension of indoor unit

The indoor unit should be suspended as shown in the below sketch:

1. Adjust the relative position of the suspension hook on the suspension bolt.
2. Tighten the bolt and ensure that four hooks are in close contact with the nuts and washers, and the unit is suspended firmly and reliably onto the hooks.
3. After the unit is installed ensure it is secure and does not shake or sway.
4. Ensure that the centre of the indoor unit is in alignment with the centre of the opening in the ceiling.



★ Installation of drainage pipe

1. The drain pipe should be properly insulated to prevent the generation of condensation.

It should be installed with a downward gradient (1 / 100 ~ 150).

2. The unit has a drain pump which will lift up to 1200mm. However after the pump stops the water still in the pipe will drain back and may overflow the drain tray causing a water leak. For this reason please install the drain pipe as shown on the right.

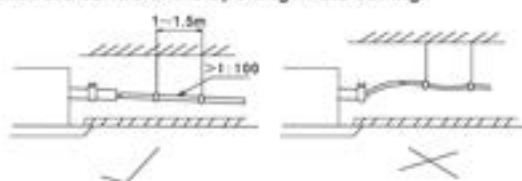

	<p>Caution</p> <p>In order to ensure the drainage water come out successfully, the unit must be horizontal or declined to drain hose when finished installation.</p>
--	---

3. When draining multiple units into a common drain line, this common drain should be installed about 100mm below each units drain outlet, as shown in the drawing on the right

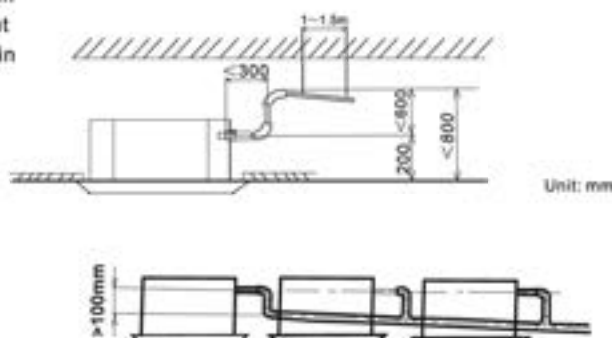

★ Grille Installation

Please refer to the picture on the right.

The grille has four clips which attach to corresponding hangers on the unit and the grille should be positioned using these first.

The grille is then fixed into position by four bolts which are accessed through the four corner panels on the grille.

The four connection bolts are located inside the inlet panel of the grille.

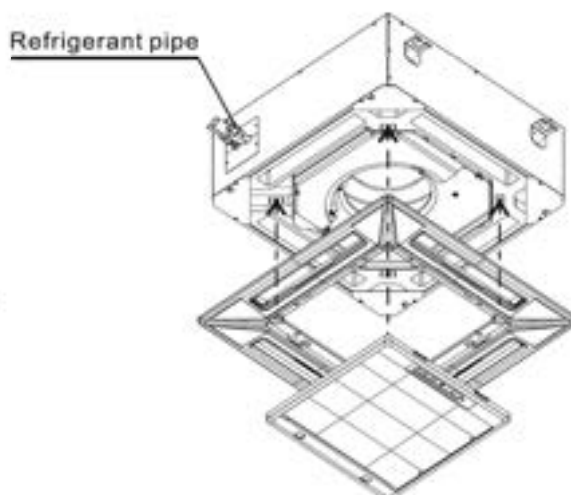

Note: During installation please ensure that the air vane motor in the grille corresponds to the position of the refrigerant pipe entry into the indoor unit.

★ Low Static Pressure Ducted Air Conditioner Unit

■ Select installation site

■ The location of hoisting bolt

For convenience of maintenance, please set a inspection port.

※After the installation site that meets the following conditions is selected and approved by customer, the installation can be carried on.

1. There are no obstacles which hinder the air circulation, so the cold air can be spread to all corners in the room.
2. The distance away from the wall and obstacles is shown in the below drawing.
3. The installation site should be convenient for water draining (See "Installation of drainage pipe" for details.)



Warning

4. For ducted type indoor unit, the suspension site should be able to support the weight 4 times more than the indoor unit. There should be no increase in noise and vibration. If it needs to be reinforced, the installation should be carried on after reinforcement (if reinforcement is poor, the indoor unit will fall and cause damage).

5. There should be no heat source and steam source near the installation site.
6. The place is near the power supply (special line).
7. The place should be easy to connect to the outdoor unit.
8. The place should keep away from direct sunlight and moisture.
9. The height inside the ceiling should reach the drainage requirements to ensure the installation of indoor unit.
10. The unit can't be installed in the washhouse (it will cause electric shock).
11. In the inlet and outlet of indoor unit, protective barriers should be installed to prevent finger from inserting or contacting the fan with high speed and metal fin.

■Matters requiring attention

Do not drop the indoor unit or allow it to fall during transport.

★ Installation

■The location of hoisting bolt

Type	A	B	C
7000BTU			
9000BTU	532	700	734
12000BTU			
18000BTU	832	1000	1048

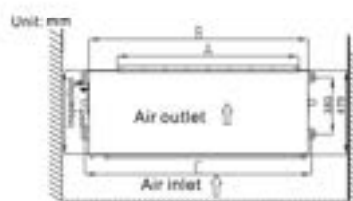

■The suspension drawing of indoor unit

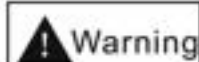

Warning

Must seriously fasten bolts and nuts. The loosening would lead to air-conditioner falling and so on.

■Duct and drain pipe installation

There are two installation methods of duct, as follows.

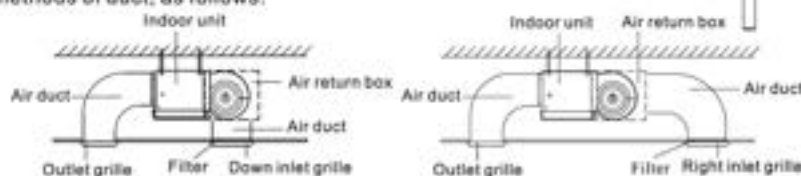

- Use canvas to connect the indoor unit and duct in order to reduce unnecessary vibration.
- As shown, the indoor unit should be leaning to the drain hole to be convenient for drainage.

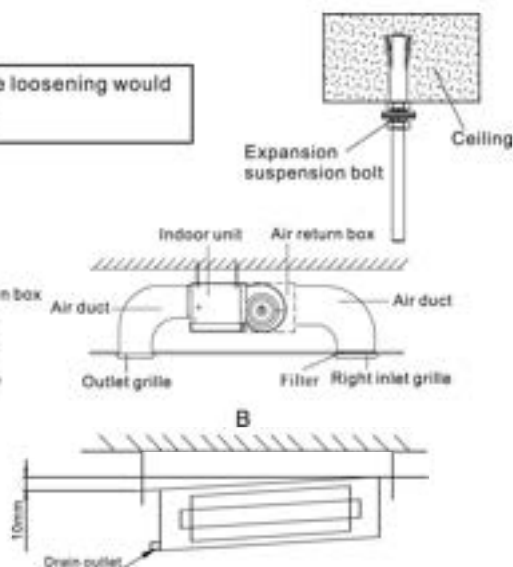

★Installation of drainage pipe

1. The drain pipe must have a downward gradient (1 / 50 ~ 1 / 100).
If the drain pipe is installed ups and downs or upward, it will lead to water backflow or leakage etc.
2. During pipe connection, do not use too much force to the drain joint of indoor unit.
3. The joint is PT1.
4. There is a drain hole on each side of indoor unit; unused drain pipe must be closed.

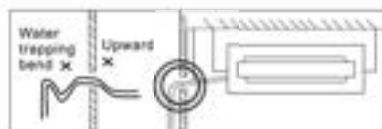

Note: The drain pipe must be wrapped heat insulation material, otherwise it will cause condensation or water drops.

Heat insulation material: rubber insulation pipe with thickness more than 8mm



★Wall-mounted Air Conditioner Unit



- First make changes to wall and make sure that is hard and secure. Using four "+" type screws to fasten the installation board onto the wall. Keep it water lever horizontal direction and perpendicular in vertical direction. Otherwise it might cause water drops when air-conditioner is running cooling operation.

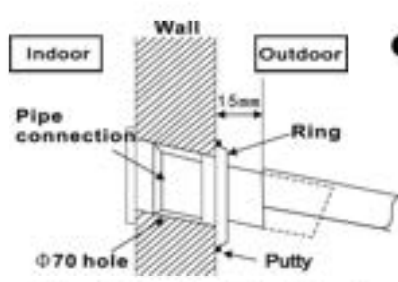
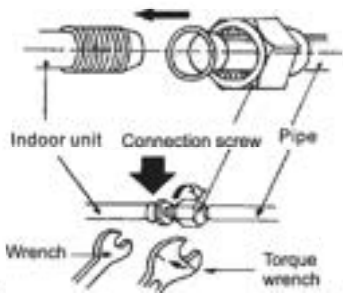

● Drilling 70mm diameter pipe hole at the left down or right down side of the installation board. The hole shall slant outward slightly.

● Pull out the indoor unit pipes after detached the fixed parts on them. Connect the interconnected pipes to the indoor unit: point to the center of pipe and fasten the connection screw at first by hand and then by wrench until you hear the "Click" sound. Fastening direction is shown in the right picture. Using torque is shown in the following table.

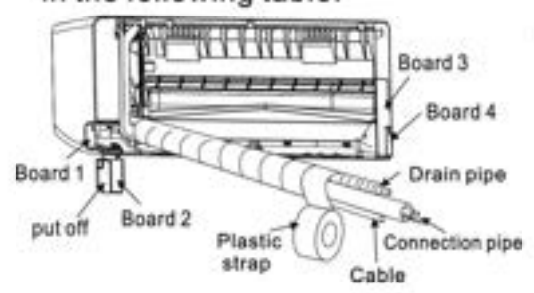

● Before installation, confirm connection pipes' direction. Remove the board 1 and board 2 on the correct connecting side. Press connection pipes to the board gap, then install board 2 to the original location. If connection pipes are on the other side, install them as above.

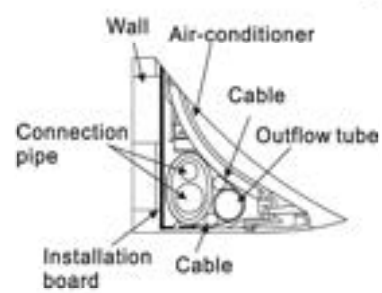

Note: The installed air-conditioner won't be tightly appressed to the wall if that is not arranged shown in the picture. The outflow tube must be in the bottom and the highest point of it can not exceed the position of water basin.

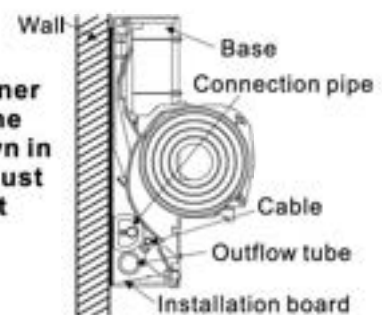

★ Check the water exhausting

1. Take off the frame the unit cover. Take off the front frame for maintenance according to the following steps:
 - Turn perpendicular airflow direction handle from "I" to horizontal direction.
 - As shown in the picture on the right, take off two covers from the front frame and then unfasten two fixture screws.
 - Pull the front frame towards yourself and take it off.

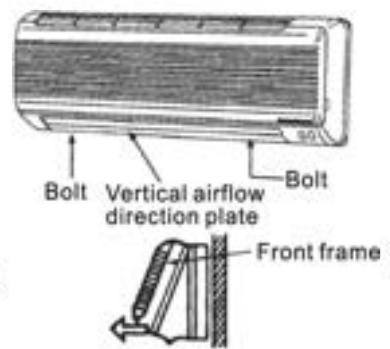

In case that put the front frame back, turn the perpendicular airflow direction handle from "I" to horizontal, then proceed according to the third and the second steps. You should check whether the front frame is firmly inside the fixture groove on the top.

Pull down the front frame towards your and take off the front frame.

2. Check the water exhausting.
 - Put a cup of water into groove.
 - Check whether the water flow through the water exhausting hole.

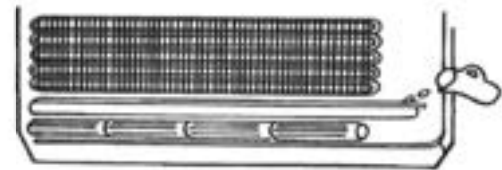

Installation of the outdoor unit

- The outdoor unit must be firmly fixed to avoid falling in the strong wind.
- Install on the cement base the drawing below.
- If it will be installed at seaside or at a place high above the ground and with strong wind, the AC should be installed against the wall to ensure the normal operation of the fan and the blocking plate should be used.
- If it will be installed in type, the structure of the mounting surface should be made of solid stick, cement or materials with equivalent strength, and be of enough bearing capacity. Otherwise, measures such as reinforcement, support or vibration damping should be adopted.

Installation outdoor unit bolt

Model	Unit Size	A(mm)	B(mm)
1 drive 2	800x315x545	545	315
1 drive 3	834x328x655	540	335
1 drive 4	985x395x808	675	409
1 drive 5			

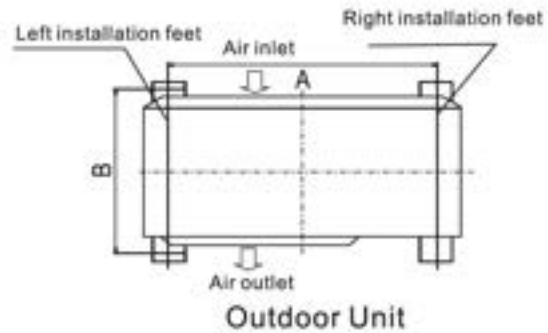

Pipe connection

- Connect the pipe to the unit: point to the center of pipe and fasten by wrench until it is tightly fastened, the fastening direction is in the following picture.

The size of pipe	Torque
$\Phi 6.35\text{mm}(1/4")$	18N.m
$\Phi 9.52\text{mm}(3/8")$	42N.m
$\Phi 12.7\text{mm}(1/2")$	55N.m
$\Phi 15.88\text{mm}(5/8")$	75N.m

Note: Carefully check if there is any damage of joints before installation. The joints shall not be reused, unless after re-flaring the pipe.

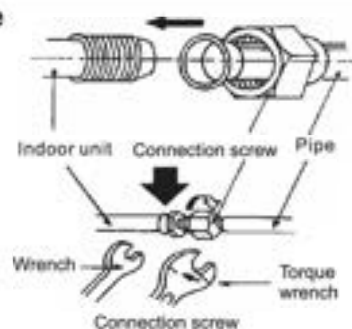

- Pointing towards the center of pipe, fasten the screw with strength.
- Wrench the screw in the end until you hear the "Click" sound.



Refer the direction to the picture

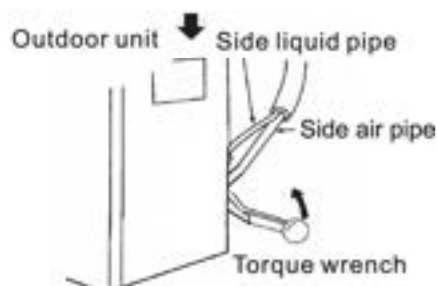

★ The form of pipe

Use sealing tape to cover the small leaks on the external ring of the pipe

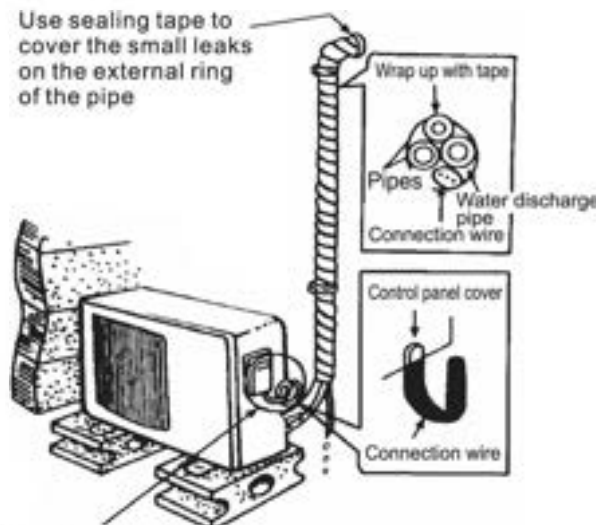

Round in this shape to prevent water entering the electrical parts

- Wrap up all pipe, water discharge and connection wire from top to below.
- Cover the connection and fix them with two plastic rings.
- Wrap up the pipes with tape alongside the wall and fix them to the wall with clips. These steps are usually adopted when outdoor unit is installed below the indoor unit.

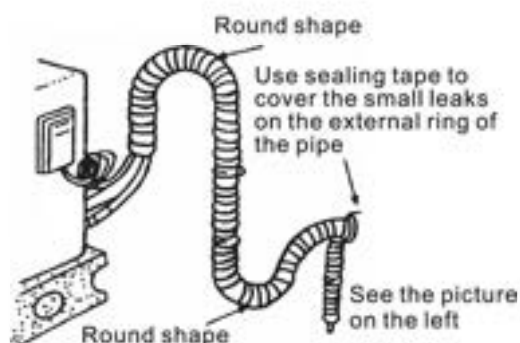

- In case that you want to have additional water discharge pipe, the end of pipe should be within certain distance towards to surface (don't let it under the water. Fix it onto the wall so it won't be swayed by the wind).
- Wrap the pipes and connection wire well from below to top.
- Wrap up the pipes that are rounded up by the wall corners in the way shown in the picture so it can prevent water entering the room.
- Use clips or other fixture to fasten the pipes to the walls.

★ Expelling the air in the pipes and the indoor unit

Exclusive R32 refrigerant pump must be used in making R32 refrigerant vacuum.

- 1、 Connect the pipes of indoor units and outdoor unit according to the figure below, and tighten all the bell coupling nuts of indoor and outdoor to prevent leakage.
- 2、 Connect the cut-off valves, charge hose, manifold valve, vacuum pump as the figure below.
- 3、 Please fully open the manifold valve handle Lo and Hi, and do the vacuum processing, vacuum should be running more than 15 minutes, make sure the vacuum gauge indicates the pressure has reached -0.1MPa (-76cmHg);
- 4、 After completion of vacuum processing, use the hex wrench to open a little the liquid valve of unit A and unit B, and then quickly remove the hose of gas valve (remove the hose to prevent air from entering the system);
- 5、 Open all the cut-off valve and check the connecting mouth of indoor and outdoor, then cover the cut-off valves after confirm there is no leak.

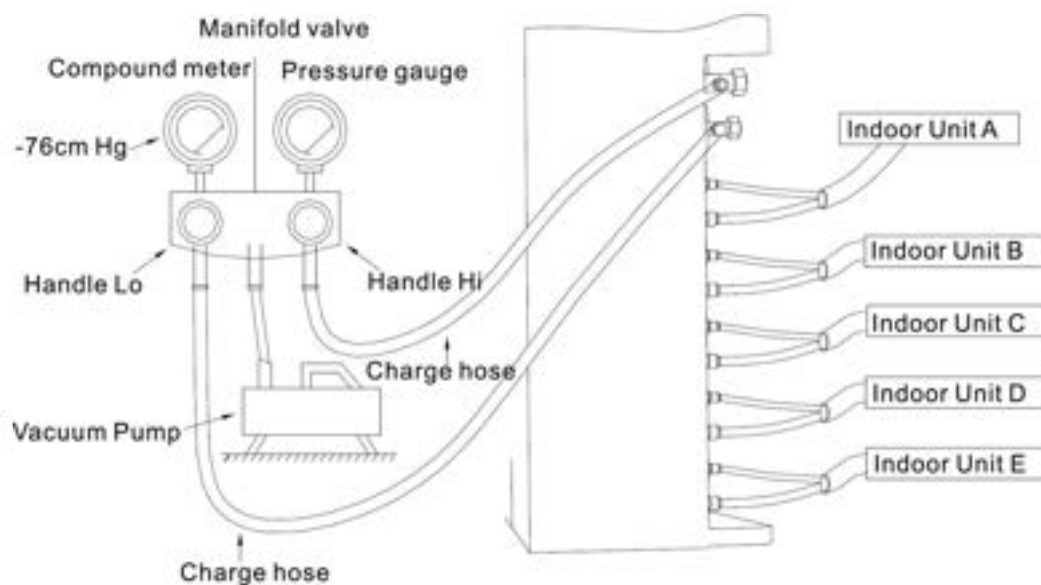

Electrical connection

The wiring cable specification that is needed in the installation:

Wiring Type	Cross-sectional area (mm ²)	Switch / fuse nominal value (A)
Power line (3 core wire)	2.5(14k/18k/21k/27k) 4(36k/42k)	32/25
Connection wire (4 core wire)	1.5	/

Connection wire between indoor and outdoor: The outdoor unit has three(AM2) /four(AM3) terminal boards, they are connected to power supply, the indoor unit A, the indoor unit B, the indoor unit C. Specific connection method as shown below:

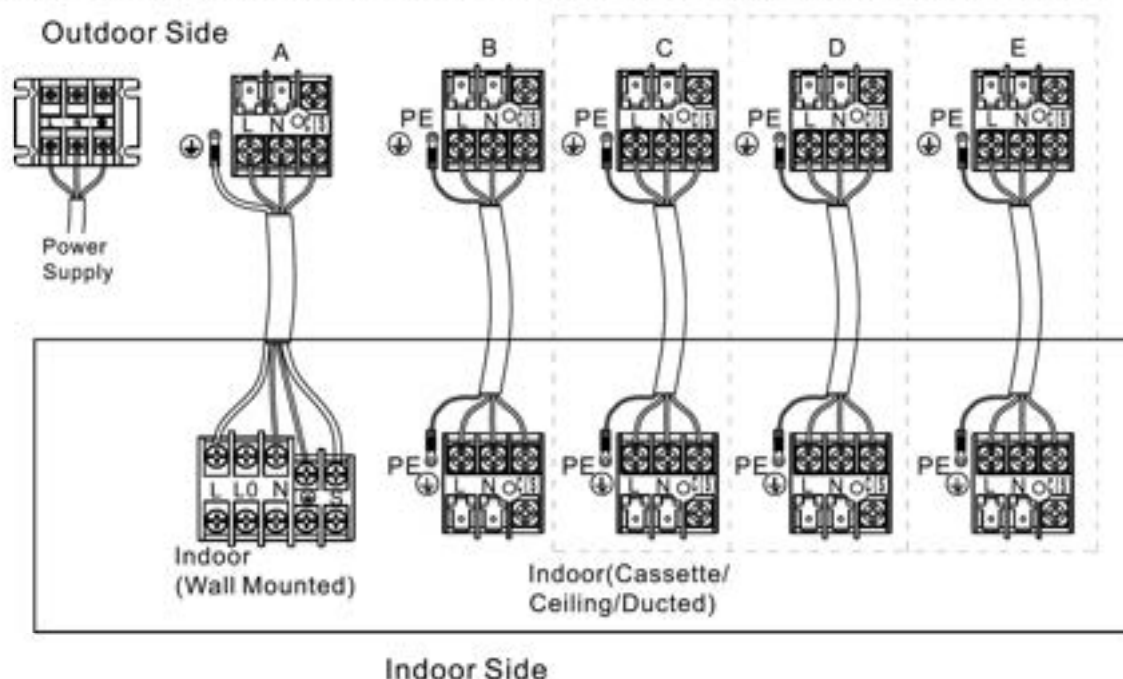

NOTE:

- ※The connection wire of indoor units should be connected to the corresponding terminal board, that is the power core of A can't connected to the outdoor terminal board for B, otherwise it will cause the unit failure or even damage the units.
- ※Connect the grounded wire correctly, otherwise will cause the malfunction of some electrical component and shock or fire indeed.
- ※Don't reverse the power polarity.
- ※Must fix the screw nail of the firmly wire, then drag the wire lightly, confirmation whether it's firmly.
- ※If there is a connector, connect it directly.

Test running

- Make sure that pipes and wires are connected.
 - Make sure that liquid side valve and air side valve both are completely open.
- 1. The connection of power source**
- Connect the wire to independent power source socket.
 - Preparation of remote controller.
 - Run the air-conditioner in cooling operation mode for 30 minutes or longer.
- 2. Performance evaluation**
- Test the out and in air temperature.
 - Make sure whether the outlet air temperature subtract from inlet's gives more than 10°C .

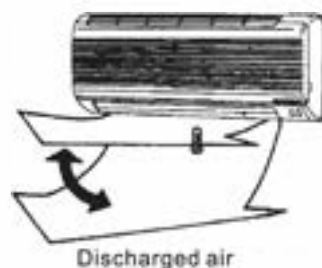

Maintenance Notice

Attention:

For maintenance or scrap, please contact authorized service centers.

Maintenance by unqualified person may cause dangers.

Feed air conditioner with R32 refrigerant, and maintain the air conditioner in strictly accordance with manufacturer's requirements. The chapter is mainly focused on special maintenance requirements for appliance with R32 refrigerant. Ask repairer to read after-sales technical service handbook for detailed information.

★ Qualification requirements of maintenance personnel

- 1.Special training additional to usual refrigerating equipment repair procedures is required when equipment with flammable refrigerants is affected. In many countries, this training is carried out by national training organisations that are accredited to teach the relevant national competency standards that may be set in legislation. The achieved competence should be documented by a certificate.
- 2.The maintenance and repair of the air conditioner must be conducted according to the method recommended by the manufacturer. If other professionals are needed to help maintain and repair the equipment, it should be conducted under the supervision of individuals who have the qualification to repair AC equipped with flammable refrigerant.

★ Inspection of the Site

Safety inspection must be taken before maintaining equipment with R32 refrigerant to make sure the risk of fire is minimized. Check whether the place is well ventilated, whether anti-static and fire prevention equipment is perfect.

While maintaining the refrigeration system, observe the following precautions before operating the system.

★ Operating Procedures

1.General work area:

All maintenance staff and others working in the local area shall be instructed on the nature of work being carried out. Work in confined spaces shall be avoided. The area around the workspace shall be sectioned off. Ensure that the conditions within the area have been made safe by control of flammable material.

2. Checking for presence of refrigerant:

The area shall be checked with an appropriate refrigerant detector prior to and during work, to ensure the technician is aware of potentially toxic or flammable atmospheres. Ensure that the leak detection equipment being used is suitable for use with all applicable refrigerants, i.e.non-sparking, adequately sealed or intrinsically safe.

3.Presence of fire extinguisher:

If any hot work is to be conducted on the refrigeration equipment or any associated parts, appropriate fire extinguishing equipment shall be available to hand. Have a dry powder or CO₂ fire extinguisher adjacent to the charging area.

Maintenance Notice

4.No ignition sources:

No person carrying out work in relation to a refrigeration system which involves exposing any pipe work shall use any sources of ignition in such a manner that it may lead to the risk of fire or explosion. All possible ignition sources, including cigarette smoking, should be kept sufficiently far away from the site of installation, repairing, removing and disposal, during which refrigerant can possibly be released to the surrounding space. Prior to work taking place, the area around the equipment is to be surveyed to make sure that there are no flammable hazards or ignition risks.

'No Smoking' signs shall be displayed.

5.Ventilated Area(open the door and window):

Ensure that the area is in the open or that it is adequately ventilated before breaking into the system or conducting any hot work. A degree of ventilation shall continue during the period that the work is carried out. The ventilation should safely disperse any released refrigerant and preferably expel it externally into the atmosphere.

6.Checks to the refrigeration equipment:

Where electrical components are being changed, they shall be fit for the purpose and to the correct specification. At all times the manufacturer's maintenance and service guidelines shall be followed. If in doubt, consult the manufacturer's technical department for assistance. The following checks shall be applied to installations using flammable refrigerants:

- The charge size is in accordance with the room size within which the refrigerant containing parts are installed.
- The ventilation machinery and outlets are operating adequately and are not obstructed.
- If an indirect refrigerating circuit is being used, the secondary circuit shall be checked for the presence of refrigerant.
- Refrigeration pipe or components are installed in a position where they are unlikely to be exposed to any substance which may corrode refrigerant containing components, unless the components are constructed of materials which are inherently resistant to being corroded or are suitably protected against being so corroded.

7.Checks to electrical devices:

Repair and maintenance to electrical components shall include initial safety checks and component inspection procedures. If a fault exists that could compromise safety, then no electrical supply shall be connected to the circuit until it is satisfactorily dealt with. If the fault cannot be corrected immediately but it is necessary to continue operation, an adequate temporary solution shall be used. This shall be reported to the owner of the equipment so all parties are advised.

Initial safety checks shall include:

- That capacitors are discharged: this shall be done in a safe manner to avoid possibility of sparking.
- That no live electrical components and wiring are exposed while charging, recovering or purging the system.
- Keep continuity of earthing.

Maintenance Notice

★ Inspection of Cable

Check the cable for wear, corrosion, overvoltage, vibration and check if there are sharp edges and other adverse effects in the surrounding environment. During the inspection, the impact of aging or the continuous vibration of the compressor and the fan on it should be taken into consideration.

★ Leakage check of R32 refrigerant

Note: Check the leakage of the refrigerant in an environment where there is no potential ignition source. No halogen probe (or any other detector that uses an open flame) should be used.

Leak detection method:

For systems with refrigerant R32, electronic leak detection instrument is available to detect and leak detection should not be conducted in environment with refrigerant. Make sure the leak detector will not become a potential source of ignition, and is applicable to the measured refrigerant. Leak detector shall be set for the minimum ignitable fuel concentration (percentage) of the refrigerant. Calibrate and adjust to proper gas concentration (no more than 25%) with the used refrigerant.

The fluid used in leak detection is applicable to most refrigerants. But do not use chloride solvents to prevent the reaction between chlorine and refrigerants and the corrosion of copper pipeline.

If you suspect a leak, then remove all the fire from the scene or put out the fire.

If the location of the leak needs to be welded, then all refrigerants need to be recovered, or, isolate all refrigerants away from the leak site (using cut-off valve). Before and during the welding, use OFN to purify the entire system.

★ Removal and Vacuum Pumping

1. Make sure there is no ignited fire source near the outlet of the vacuum pump and the ventilation is well.
2. Allow the maintenance and other operations of the refrigeration circuit should be carried out according to the general procedure, but the following best operations that the flammability is already taken into consideration are the key. You should follow the following procedures:
 - Remove the refrigerant.
 - Decontaminate the pipeline by inert gases.
 - Evacuation.
 - Decontaminate the pipeline by inert gases again.
 - Cut or weld the pipeline.
3. The refrigerant should be returned to the appropriate storage tank. The system should be blown with oxygen free nitrogen to ensure safety. This process may need to be repeated for several times. This operation shall not be carried out using compressed air or oxygen.

Maintenance Notice

3. Through blowing process, the system is charged into the anaerobic nitrogen to reach the working pressure under the vacuum state, then the oxygen free nitrogen is emitted to the atmosphere, and in the end, vacuumize the system. Repeat this process until all refrigerants in the system is cleared. After the final charging of the anaerobic nitrogen, discharge the gas into the atmosphere pressure, and then the system can be welded. This operation is necessary for welding the pipeline.

★ Procedures of Charging Refrigerants

As a supplement to the general procedure, the following requirements need to be added:

- Make sure that there is no contamination among different refrigerants when using a refrigerant charging device. The pipeline for charging refrigerants should be as short as possible to reduce the residual of refrigerants in it.
- Storage tanks should remain vertically up.
- Make sure the grounding solutions are already taken before the refrigeration system is charged with refrigerants.
- After finishing the charging (or when it is not yet finished), label the mark on the system.
- Be careful not to overcharge refrigerants.

★ Scrap and Recovery

Scrap:

Before this procedure, the technical personnel shall be thoroughly familiar with the equipment and all its features, and make a recommended practice for refrigerant safe recovery. For recycling the refrigerant, shall analyze the refrigerant and oil samples before operation. Ensure the required power before the test.

1. Be familiar with the equipment and operation.
2. Disconnect power supply.
3. Before carrying out this process, you have to make sure:
 - If necessary, mechanical equipment operation should facilitate the operation of the refrigerant tank.
 - All personal protective equipment is effective and can be used correctly.
 - The whole recovery process should be carried out under the guidance of qualified personnel.
 - The recovering of equipment and storage tank should comply with the relevant national standards.
4. If possible, the refrigerating system should be vacuumized.
5. If the vacuum state can't be reached, you should extract the refrigerant in each part of the system from many places.
6. Before the start of the recovery, you should ensure that the capacity of the storage tank is sufficient.
7. Start and operate the recovery equipment according to the manufacturer's instructions.

Maintenance Notice

8. Don't fill the tank to its full capacity (the liquid injection volume does not exceed 80% of the tank volume).
9. Even the duration is short, it must not exceed the maximum working pressure of the tank.
10. After the completion of the tank filling and the end of the operation process, you should make sure that the tanks and equipment should be removed quickly and all closing valves in the equipment are closed.
11. The recovered refrigerants are not allowed to be injected into another system before being purified and tested.

Note: The identification should be made after the appliance is scrapped and refrigerants are evacuated. The identification should contain the date and endorsement. Make sure the identification on the appliance can reflect the flammable refrigerants contained in this appliance.

Recovery:

1. The clearance of refrigerants in the system is required when repairing or scrapping the appliance. It is recommended to completely remove the refrigerant.
2. Only a special refrigerant tank can be used when loading the refrigerant into the storage tank. Make sure the capacity of the tank is appropriate to the refrigerant injection quantity in the entire system. All tanks intended to be used for the recovery of refrigerants should have a refrigerant identification (i.e. refrigerant recovery tank). Storage tanks should be equipped with pressure relief valves and globe valves and they should be in a good condition. If possible, empty tanks should be evacuated and maintained at room temperature before use.
3. The recovery equipment should be kept in a good working condition and equipped with equipment operating instructions for easy access. The equipment should be suitable for the recovery of R32 refrigerants. Besides, there should be a qualified weighting apparatus which can be normally used. The hose should be linked with detachable connection joint of zero leakage rate and be kept in a good condition.
Before using the recovery equipment, check if it is in a good condition and if it gets perfect maintenance. Check if all electrical components are sealed to prevent the leakage of the refrigerant and the fire caused by it. If you have any question, please consult the manufacturer.
4. The recovered refrigerant shall be loaded in the appropriate storage tanks, attached with a transporting instruction, and returned to the refrigerant manufacturer. Don't mix refrigerant in recovery equipment, especially a storage tank.
5. The space loading R32 refrigeration can't be enclosed in the process of transportation. Take anti electrostatic measures if necessary in transportation. In the process of transport, loading and unloading, necessary protective measures must be taken to protect the air conditioner to ensure that the air conditioner is not damaged.
6. When removing the compressor or clearing the compressor oil, make sure the compressor is pumped to an appropriate level to ensure that there is no residual R32 refrigerants in the lubricating oil. The vacuum pumping should be carried out before the compressor is returned to the supplier. Ensure the safety when discharging oil from the system.

Notatki

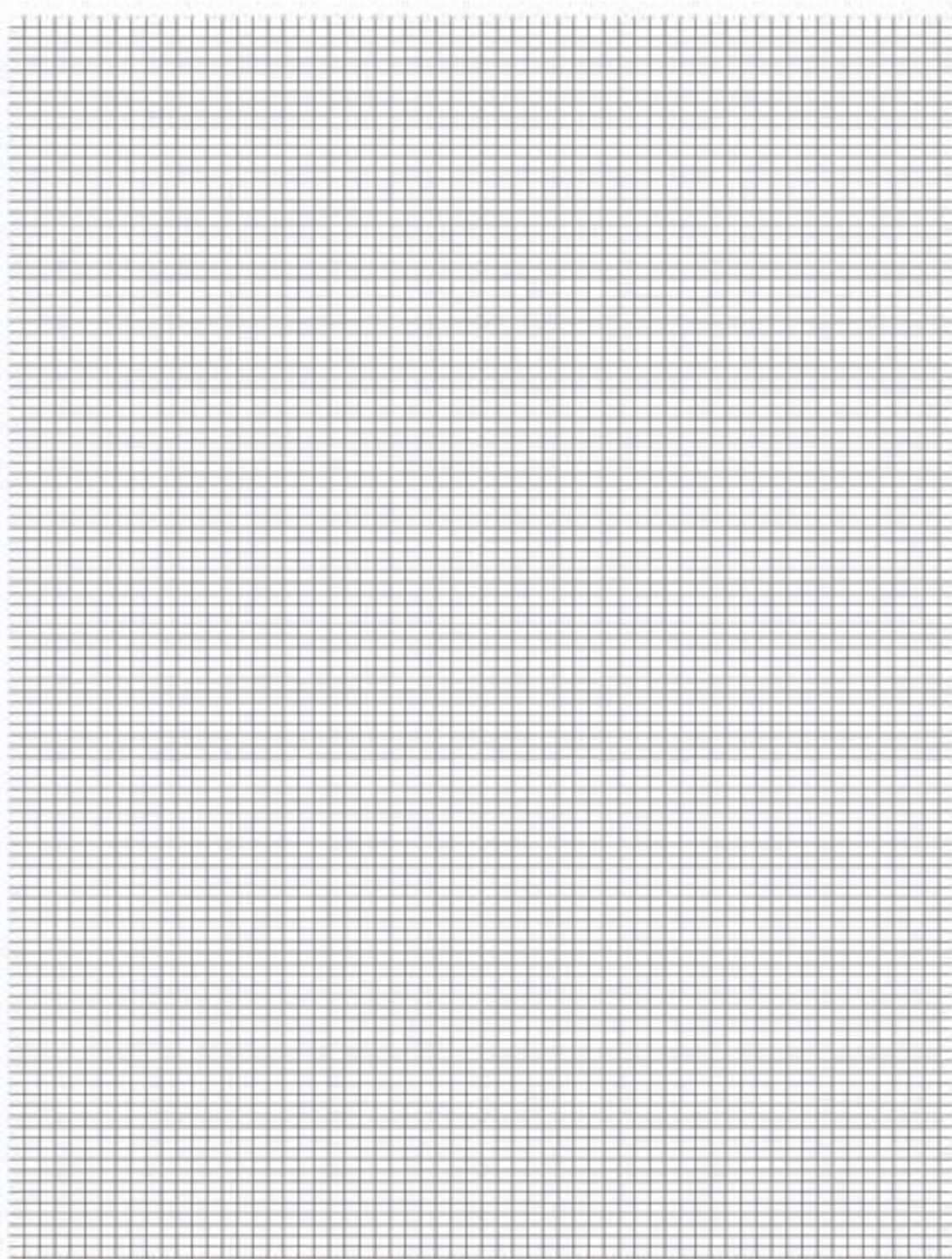

Notatki

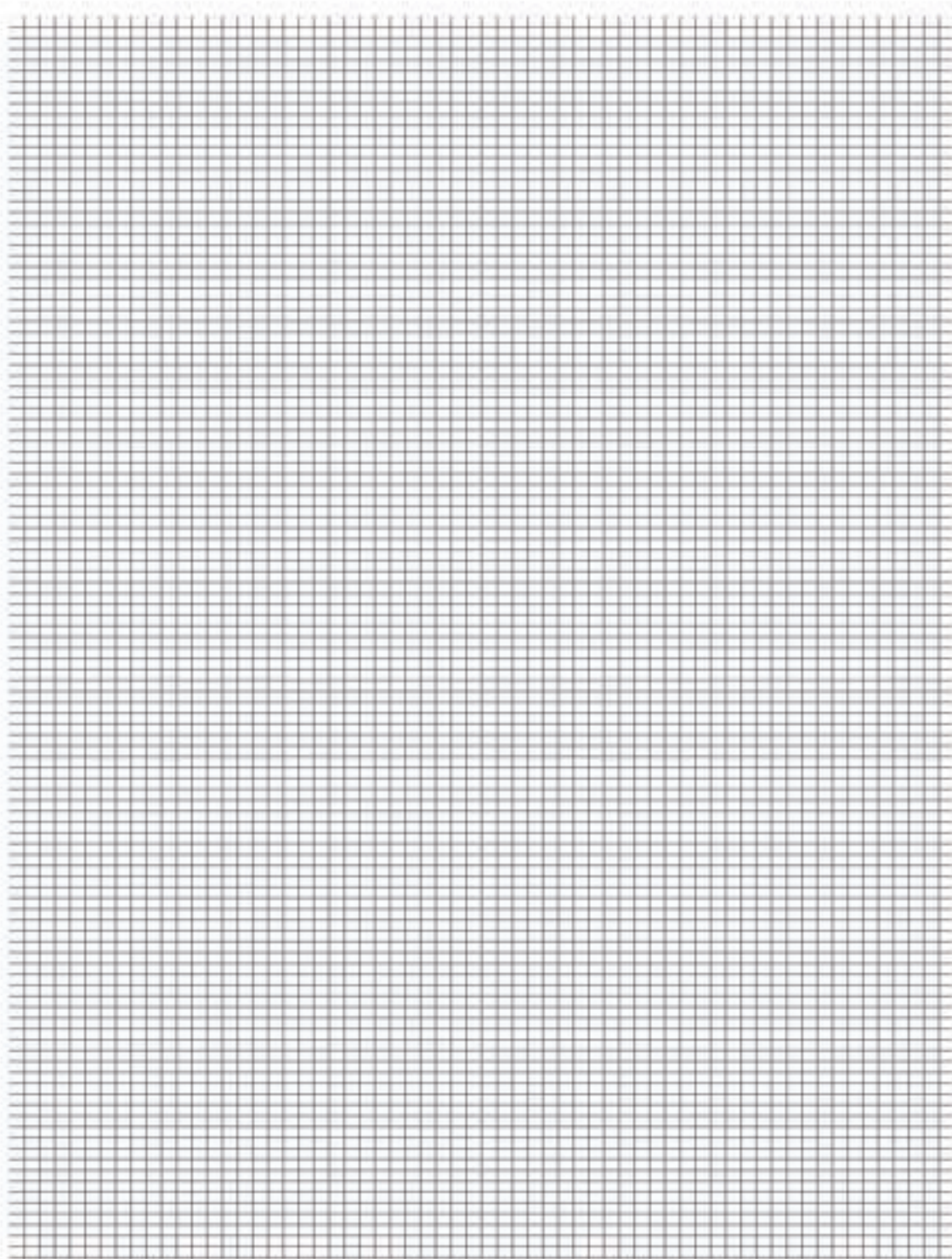

Notatki

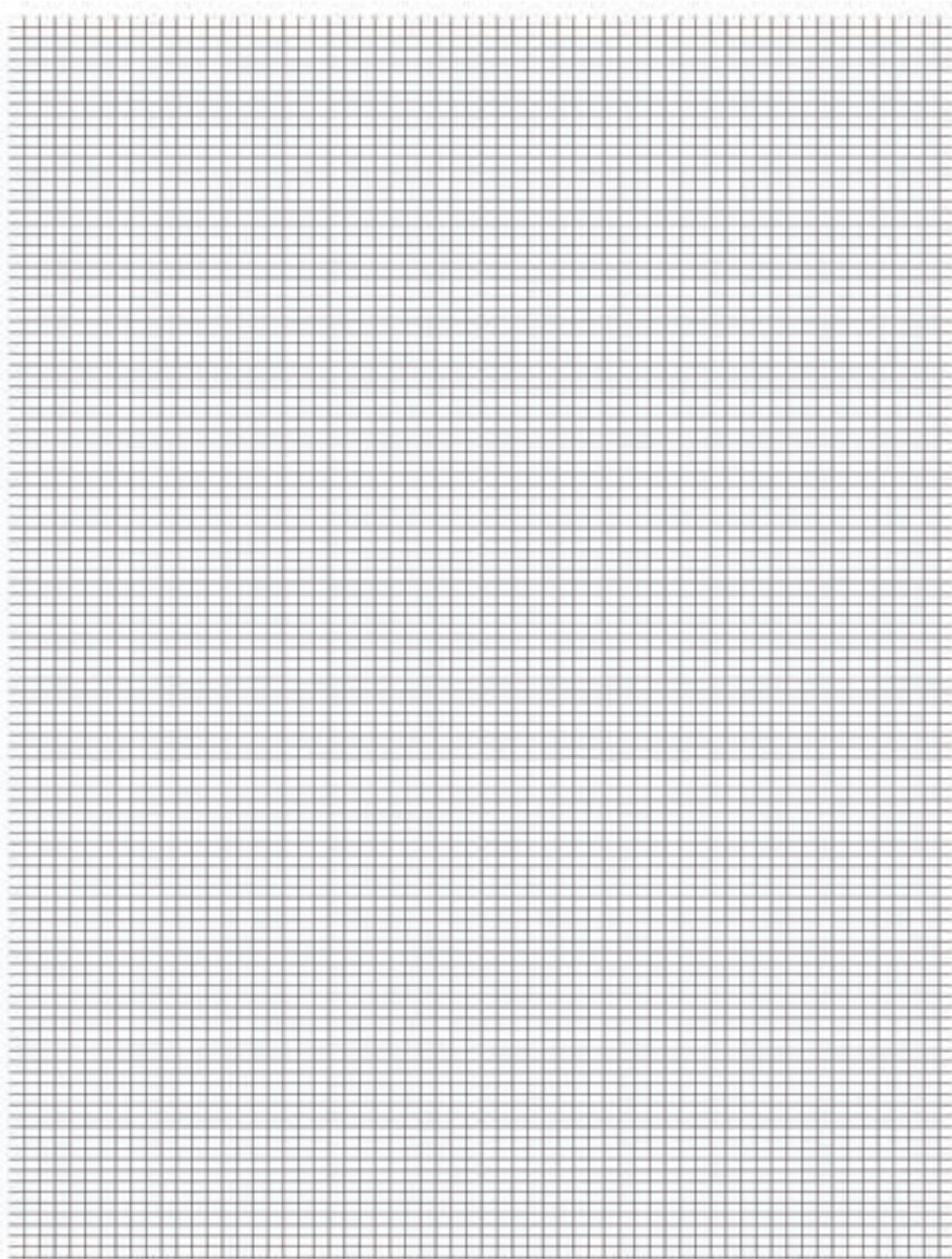



WIENKRA
KOMPLEKSOWA OBSŁUGA BRANŻY HVACR

Wyłączny importer:

WIENKRA Sp. z o.o.

🌐 www.wienkra.pl

Biura handlowe:

📍 31-539 Kraków, ul. Kotlarska 34

☎ +48 12 428 55 00, fax 12 422 55 02

✉ wienkra@wienkra.pl

📍 02-593 Warszawa, ul. Chodkiewicza 3

☎ +48 509 358 300

✉ wienkra-waw@wienkra.pl

AUX

Producent (Manufacturer):

NINGBO AUX ELECTRIC CO., LTD.

📍 No.1166 Noth MingGuang Road, JiangShan Town, Ningbo, Zhejiang, P.R.China

🌐 www.cnaux.com

